

Engine output: **13.1 PS / 9.6 kW**

Machine weight (Cabin / Canopy): **1,470 / 1,420 kg**

For Earth, For Life
Kubota

KX015-4

KUBOTA MINI EXCAVATOR



SUPERIOR PERFORMANCE/ DELUXE INTERIOR

Kubota's new KX015-4 mini excavator raises the standard in the 1.5-2.0 tonne category with a powerful digging force and a wider working range that rival higher-end excavators. And with enhanced accessibility to sites such as roadsides or residential areas, the KX015-4 gets the jobs done easier from large construction areas to small places.





Enhanced digging force

The KX015-4 delivers an impressive bucket digging force. Its powerful and well-balanced arm and bucket allow the operator to dig faster and more efficiently even in the toughest conditions.

Kubota original engine

The KX015-4 is powered by Kubota's impressive D782 13.1 PS engine. Engineered with the power to maximise digging and lifting performance, it also delivers minimised noise and vibration, meeting the engine emission regulations.

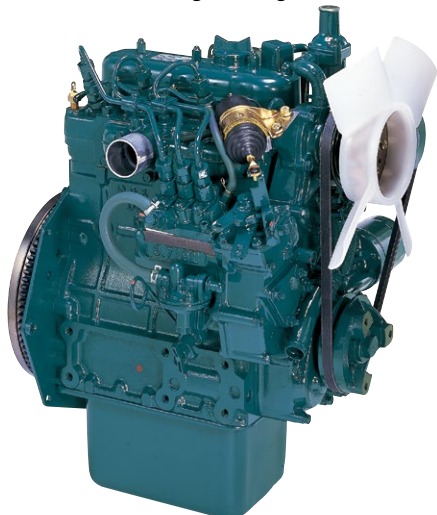

Spacious cabin

To minimise fatigue, our deluxe cabin delivers more comfort over our previous model. It provides more legroom with a flat floor plus an adjustable suspension seat.



EASY MAINTENANCE/



Time



Hour meter



Tachometer

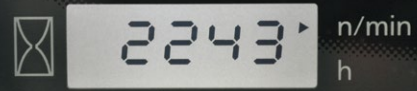

- A. Fuel level gauge**
- B. Water temperature gauge**
- C. Warning lamps**
(overheating, hydraulic, battery)
- D. LCD display (time, hour, rpm)**



Easy cabin entry and exit

Increasing the cabin door width by 30% at the narrowest point allows quick access to and from the cabin making operations that require frequent exiting, such as trenching and piping, much easier.



New digital panel

Following the excellence of Kubota's Intelligent Control System, the new digital panel puts convenience at the operator's fingertips. The user-friendly digital panel is positioned to the front right corner of the operator for better visibility, and features one-touch button operation to view the time, hour meter and tachometer. Warning lamps with code numbers on the display will alert you in case of emergencies such as overheating, hydraulic problems or low battery. Programming of the anti-theft keys can also be easily performed with the digital panel. With easier access, simpler settings, easy-to-read indicators and alerts, you'll always be aware of the excavator's functioning status.



Topside boom cylinder

For increased reliability when performing in hazardous conditions, including demolition jobs when a breaker is fitted, the boom cylinder has been positioned on the topside of the boom to prevent cylinder damage.

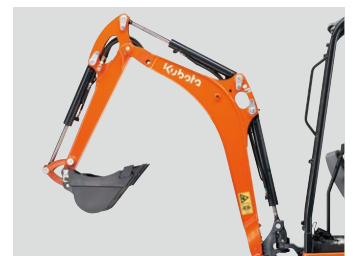

SAFETY/DURABILITY



Photo: KX016-4

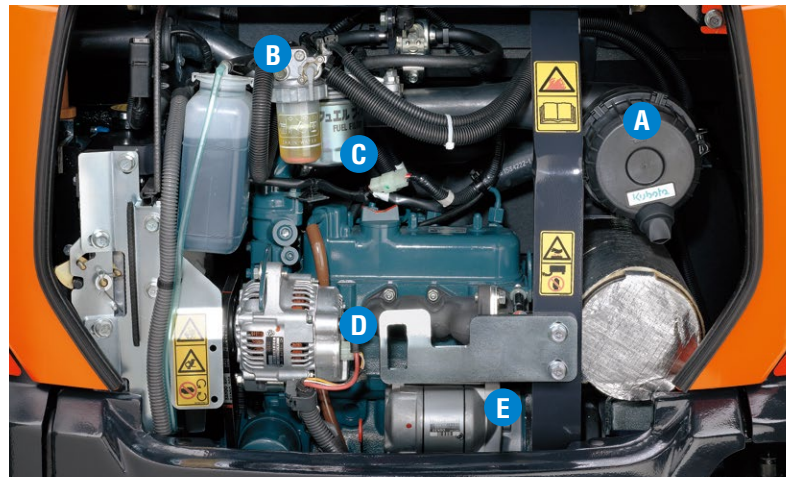

Easy maintenance

Kubota has made routine maintenance extremely simple by consolidating primary engine components onto one side for easier access. Engine and other vital components can be inspected quickly and easily.

A. Air cleaner

B. Water separator

C. Fuel filter

D. Alternator

E. Starter motor

Integrated travel motor hoses

Kubota has enclosed the travel motor hoses within the track frame for added protection.



Standard Equipment

Engine/Fuel system

- Double-element air cleaner
- Fuel refueling buzzer
- Extended fuel filler

Undercarriage

- 230 mm rubber track

Hydraulic system

- Pressure accumulator
- Hydraulic pressure checking ports
- Third line hydraulic direct return for AUX
- Variable displacement pump
- Straight travel circuit

Safety system

- Engine start safety system on the left console
- Travel lock system
- Swivel lock system
- Kubota original anti-theft system
- Battery isolator



Working equipment

- 950 mm arm

- Auxiliary hydraulic circuit piping to the arm's end
- 1 working light on the boom

Cabin

- ROPS (Roll-over Protective Structure, ISO3471)
- TOPS (Tip-Over Protective Structure)
- OPG (Operator Protective Guard, Level 1)
- Weight-adjustable semi suspension seat
- Seatbelt
- Hydraulic pilot control levers with wrist rests
- Cabin heater for defrosting and demisting with air ventilation
- Emergency exit hammer
- Front window power-assisted with gas damper
- 12V power outlet
- Location for radio
- Switch and harness for beacon light
- Digital panel with diagnosis function
- Front guard fixing point
- Side mirror

Canopy

- ROPS (Roll-over Protective Structure, ISO3471)
- TOPS (Tip-Over Protective Structure)
- OPG (Operator Protective Guard, Level 1)
- Weight-adjustable semi suspension seat
- Seatbelt
- Hydraulic pilot control levers with wrist rests

- 12V power outlet
- Switch and harness for beacon light
- Digital panel with diagnosis function
- Front guard fixing point

Optional Equipment

- Radio installation kit on the cabin (Radio bracket, antenna, 2 speakers)
- 2 working lights on the cabin/canopy
- Travel pedal
- Front guard on the cabin/canopy

Kubota Genuine and Approved Parts

for maximum performance, durability and safety



SPECIFICATIONS

Model		KX015-4		
Machine weight ¹ (cabin / canopy)		kg	1470 / 1420	
Operating weight ² (cabin / canopy)		kg	1545 / 1495	
Engine	Model		D782-E3-BH	
	Type			Water-cooled, diesel engine, E-TVCS
	Output ISO9249 NET	PS/rpm	13.1 / 2300	
		kW/rpm	9.6 / 2300	
	Number of cylinders		3	
	Bore × Stroke		mm 67 × 73.6	
	Displacement		cc 778	
Dimensions	Overall width		mm 990	
	Overall height (cabin / canopy)		mm 2350 / 2330	
	Overall length		mm 3710	
	Ground clearance		mm 160	
	Dozer size (width × height)		mm 990 × 230	
	Rubber shoe width		mm 230	
	Minimum front swivel radius		mm 1490	
	Boom swing angle (left / right)		deg 75 / 60	
Hydraulic System	P1, P2		Variable displacement pump	
	Flow rate	ℓ /min	16.6 × 2	
		Hydraulic pressure MPa (kgf/cm ²)	20.6 (210)	
	P3		Gear pump	
	Flow rate	ℓ /min	10.4	
		Hydraulic pressure MPa (kgf/cm ²)	20.1 (205)	
	Auxiliary (AUX)	Max. flow rate	ℓ /min 27.0	
		Max. hydr. pressure MPa (kgf/cm ²)	20.6 (210)	
	Max. digging force	arm	kN (kgf) 7.3 (740)	
		bucket	kN (kgf) 12.7 (1300)	
Hydraulic reservoir (full)		ℓ 28		
Max. travelling speed		km/h 2.1		
Ground contact pressure (cabin / canopy)		kPa (kgf/cm ²) 25.5 (0.26) / 24.5 (0.25)		
Swivelling speed		rpm 9.1		
Fuel tank capacity		ℓ 21		
Noise level	LpA	dB (A) 78		
	LwA (2000/14/EC)	dB (A) 93		
Vibration ³	Hand arm system (ISO 5349-2:2001)	Digging	m/s ² RMS <2.5	
		Levelling	m/s ² RMS <2.5	
		Driving	m/s ² RMS <2.5	
		Idling	m/s ² RMS <2.5	
	Whole body (ISO 2631-1:1997)	Digging	m/s ² RMS <0.5	
		Levelling	m/s ² RMS <0.5	
		Driving	m/s ² RMS <0.5	
		Idling	m/s ² RMS <0.5	

¹ With 32.5 kg Kubota original bucket, full tanks, rubber shoe.

² Machine weight with 75 kg operator.

³ These values are measured under specific conditions at maximum engine speed and can deviate, depending on the operating status.

WORKING RANGE

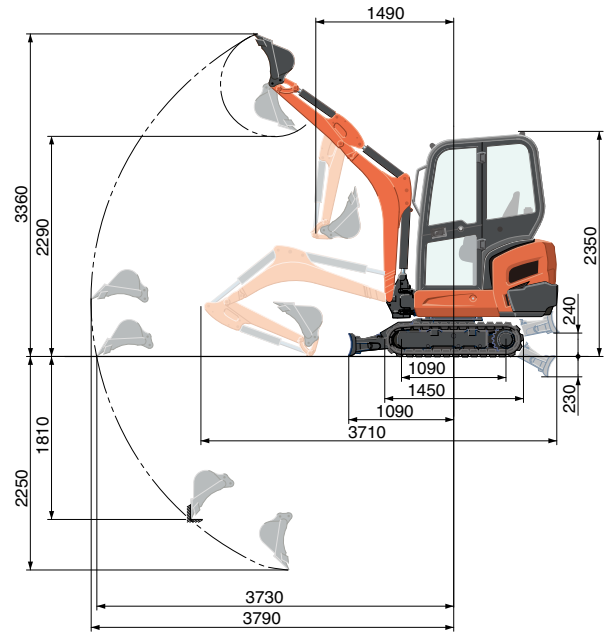
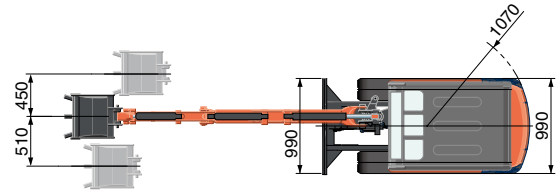

Unit: mm

LIFTING CAPACITY

Cabin, Rubber version

Lift Point Height	Lifting point radius (2m)			Lifting point radius (max.)			kN (ton)
	Over-front		Over-side	Over-front		Over-side	
	Blade Down	Blade UP		Blade Down	Blade UP		
1.5m	3.0 (0.30)	3.4 (0.35)	2.5 (0.26)	-	-	-	
1.0m	4.5 (0.46)	3.5 (0.36)	2.3 (0.24)	-	-	-	
0.5m	5.4 (0.55)	3.3 (0.34)	2.1 (0.22)	2.6 (0.27)	1.6 (0.17)	1.1 (0.11)	
0m	5.3 (0.54)	3.2 (0.32)	2.0 (0.21)	-	-	-	

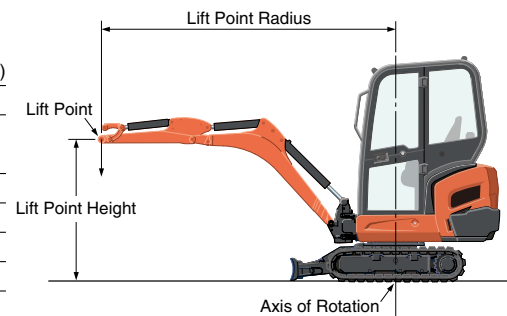

*The lifting capacities are based on ISO 10567 and do not exceed 75% of the static tilt load of the machine or 87% of the hydraulic lifting capacities of the machine.

**The excavator bucket, hook, sling and other lifting accessories are not included on this table.

* Working ranges are with Kubota original bucket, without quick coupler.

* Specifications are subject to change without notice for purpose of improvement.

★ All images shown are for brochure purposes only.

When operating the excavator, wear clothing and equipment in accordance to local legal and safety regulations.

KUBOTA (U.K.) LTD

Dormer Road, Thame, Oxfordshire,
OX9 3UN, U.K.
Phone : 01844-268140
F a x : 01844-216685

<http://www.kubota-eu.com>

